



2018 | MF TD SERIES TEDDERS

Latest Generation of High Output Tedders



FROM MASSEY FERGUSON

MFTD SERIES



Page 04
Massey Ferguson TD Series
Teddors



Page 06
Forage quality features



Page 07
Best harvest - fast and low-impact



Page 08
MF Hay Tedders trailed and with transport chassis



Page 10
Specifications

Contents

- 04 Massey Ferguson TD Series Tedders
- 06 Quality features
- 07 Best harvest - fast and low-impact
- 08 MF Hay Tedders trailed and with transport chassis
- 10 Specifications

Massey Ferguson TD Series Tedders

When it comes to drying hay, it's nearly impossible to beat Mother Nature. Of course, farmers have utilised nature's resources – like the wind and sun – for as long as seeds have been planted in the ground. Today, you can assist Mother Nature's gifts by spreading the crop with a professional-grade Massey Ferguson TD Series tedder.

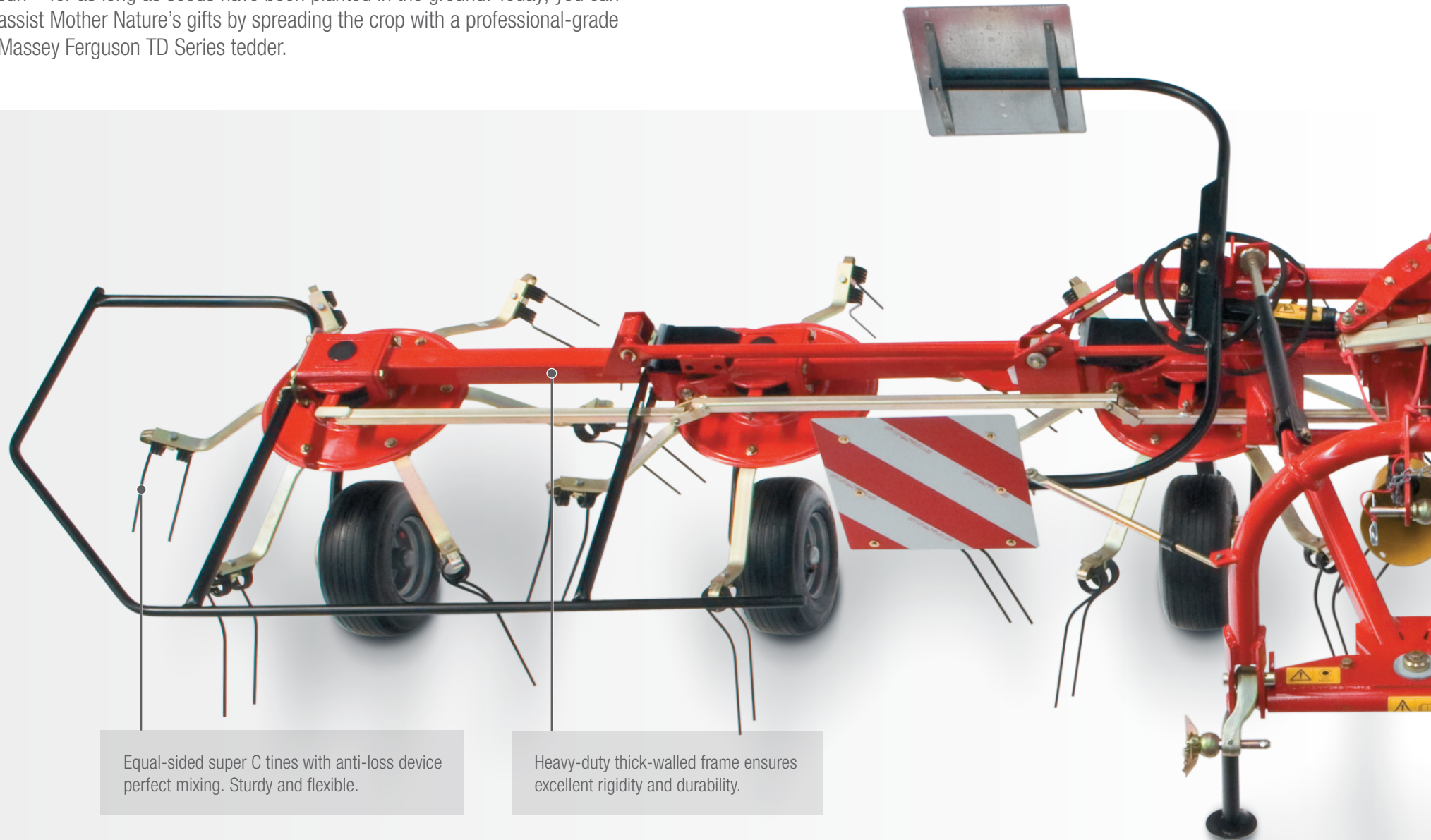

Equal-sided super C tines with anti-loss device perfect mixing. Sturdy and flexible.

Heavy-duty thick-walled frame ensures excellent rigidity and durability.

11 MF models provide tedding widths from 4.5 metres to 12.70 metres. Each one offers easily adjusted spreading angles of 15, 18 and 20.5 degrees for adaptability to all forage and crop conditions.

All MF models are simple to set-up and adjust for quick and efficient ground coverage. MF TD 454, MF TD 524, MF TD 676 and MF TD 776 models also feature synchronised lifting of exterior rotors via a centralised hydraulic lift system and pressure cylinders to ensure optimum performance and eliminate one-sided loads – even on slopes.

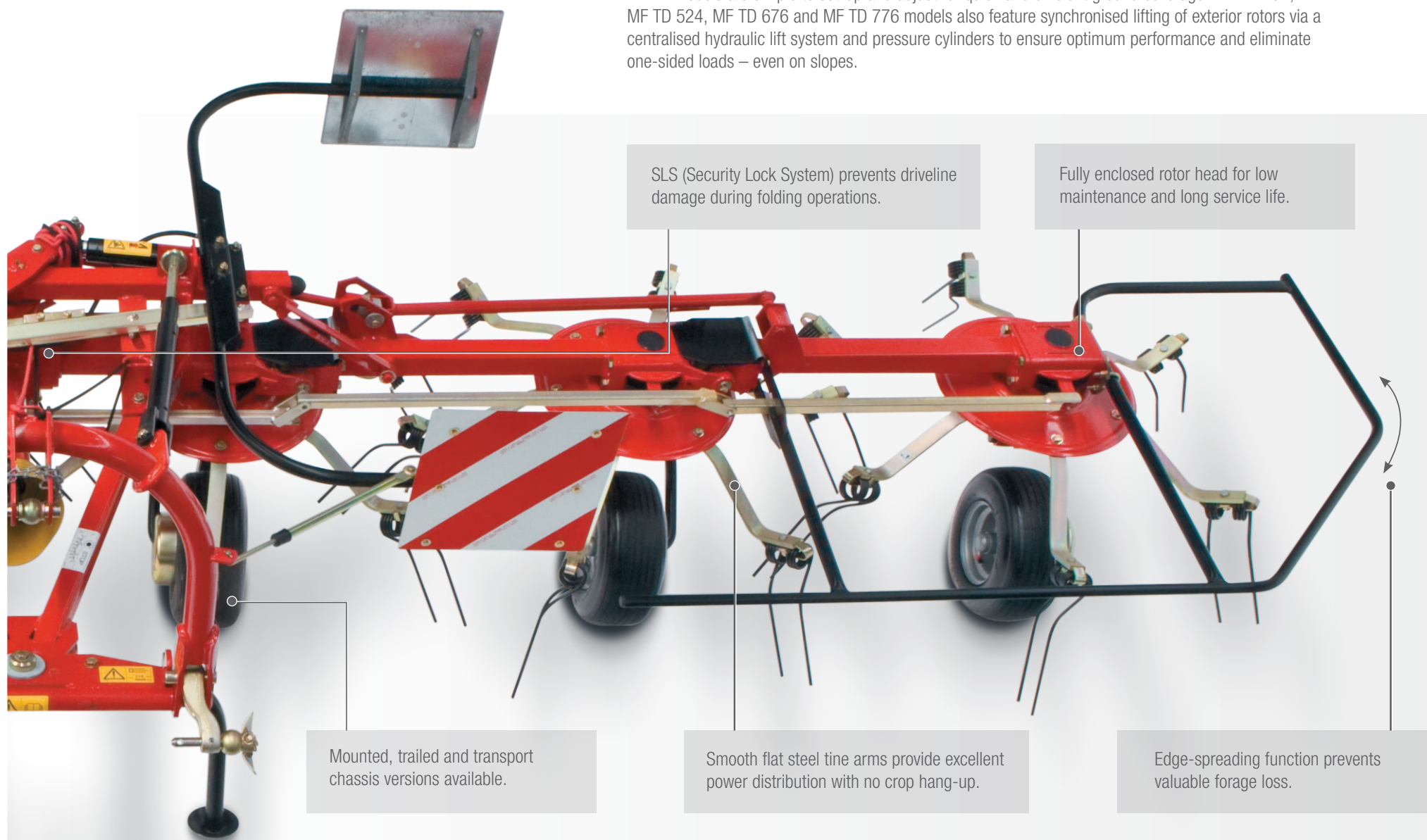

SLS (Security Lock System) prevents driveline damage during folding operations.

Fully enclosed rotor head for low maintenance and long service life.

Mounted, trailed and transport chassis versions available.

Smooth flat steel tine arms provide excellent power distribution with no crop hang-up.

Edge-spreading function prevents valuable forage loss.

Quality features

MF Tedders with Three-point linkage

Versatile high performance MF tedders, thanks to the excellent quality of work they produce and their flexibility of use.



MF Tedders trailed and with transport chassis

MF Hay tedders for fast and safe travel – compact on the road, wide coverage out in the field.

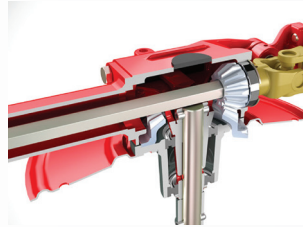
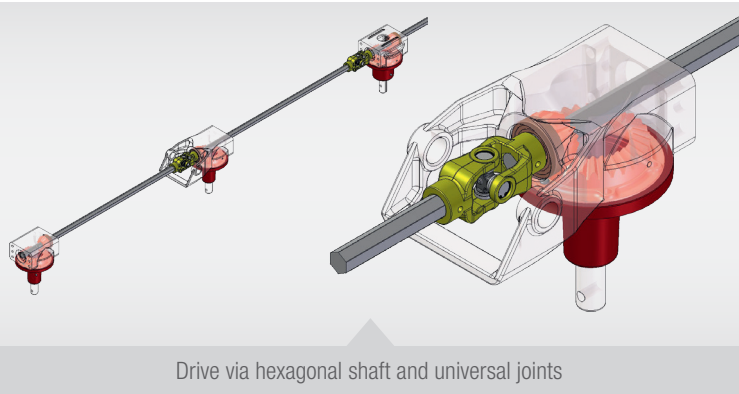

Rotor Head

Massey Ferguson rotor heads have an enclosed design which protects all important components from dirt and dust. This design provides years of trouble-free service.

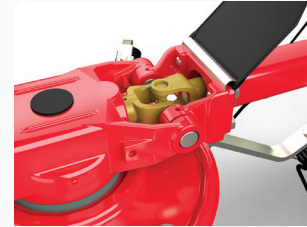

Power Train

The individual rotors are driven via a generously dimensioned hexagonal shaft and robust universal joints. This type of power transmission is smooth and reliable and free from backlash.

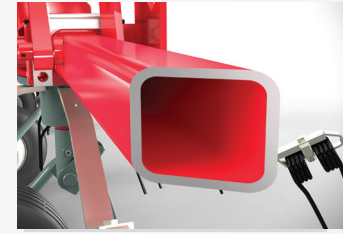

Frame

All MF hay tedders are equipped with thick-walled, strongly dimensioned square frame tubes which ensure excellent rigidity and a very long service life. The individual rotor frames are connected via sturdy frame joints with special flange sleeves and hardened pins. All joints can be relubricated for extra reliability and durability. This contributes to ensuring optimum performance even after many years of service.



MF TD SERIES

Best harvest – fast and low-impact

Comb effect – only with equal-sided tines

Only equal-sided tines allow you to achieve an optimum mixing of your high-quality forage. This is known as the comb effect since, during the process the different layers of forage are perfectly mixed together and turned, providing the optimum production of high-quality forage.

Tines with sides of equal length also provide the benefit that you do not need right-hand and left-hand tines but only one kind of tine, which makes spare parts management easier.

Tine arms

The tine arms are made of a tough, galvanised flat steel bar, which allows a wide contact surface between tine and rotor disc. This ensures excellent power transmission even under the harshest of working conditions. The forces are optimally absorbed whenever the ground is uneven.

All Massey Ferguson tedders are equipped with tine loss protection as a standard feature. This protects machines which are following behind and also your valuable livestock. The tines are secured under the tine arm. This arrangement has the advantage that the upper side is smooth and, as a result, forage will not be left hanging. It also allows the tine greater freedom of movement, which contributes to optimal processing of your high-quality forage.



Transport position



Wide contact surface for optimum power transmission

Super C – The quality feature

The Super C quality feature guarantees a high level of quality and ensures an extremely long service life. The tines used at Massey Ferguson have to undergo a test cycle and survive 200,000 impacts without damage. Special process steps are used to design and manufacture the tines for toughness, elasticity and durability.

The Super C tine has a tine diameter of 9.5 mm, a coil diameter of 70 mm and six windings, making it one of the most efficient on the market and typical of the high quality of each and every Massey Ferguson hay tedder.

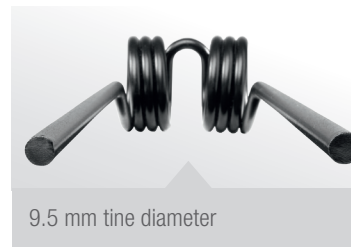

9.5 mm tine diameter



6 windings



70 mm coil diameter



Massey Ferguson Super C quality tines

MF Tedders trailed and with transport chassis

Trailed

The MF TD 1008 TR Hydro and MF TD 1310 TR Hydro offer wide working widths in a compact package. Ideal for use behind small tractors, these machines are well adapted for uneven and hilly terrain. The standard edge spreading function prevents loss of valuable forage on field headlands. The hydraulically folding function uses a single acting cylinder for simple synchronised folding.

Transport Chassis

The MF TD 776 TRC, MF TD 868 TRC, MF TD 1008 TRC and MF TD 1310 TRC are tedders that can be conveniently attached via the drawbar of the tractor. With working widths from 7.70 metres to 12.7 metres, you can easily handle any area of grassland – no matter how big. The wide transport chassis and the compact transport position ensure safe and time-saving travel from field to field – ideal for completing the job in the face of worsening weather or other time constraints.

Security comes first

Thanks to the SLS (Security Lock System) from Massey Ferguson, maximum safety for your machine is guaranteed during folding operations. SLS is an automatic, hydraulically-activated switch-off and positioning system, with integrated freewheel which interrupts the flow of power to the rotors when the halves of the machine are folded up. As a result, a high degree of safety is ensured in the transport position as well as during maintenance work. The possibility of

damage to the power train is also minimised in the event of incorrect operation.

Convenience of operation which speaks for itself

The rotors are easily folded in and out by a hydraulic sequential control system operated directly from the tractor seat.

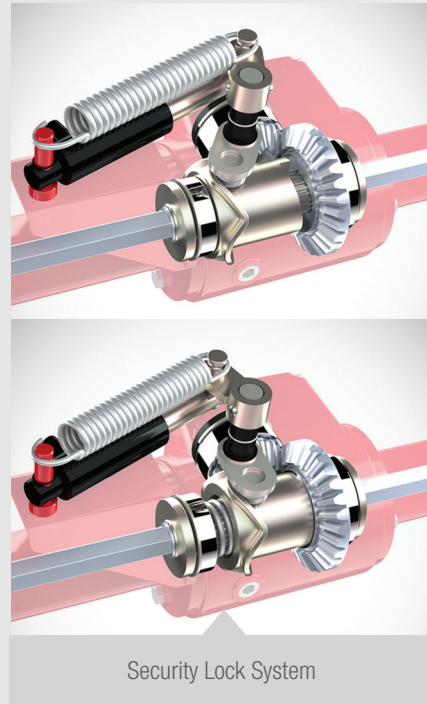

MF TD SERIES

Perfect working conditions

As with all Massey Ferguson hay tedders, the forage is picked up by the tines and turned gently, without damage. A light, loose and well mixed mat of forage is created, to help ensure a top quality end-product. With the central edge spreading device which is fitted as standard, edges of fields no longer present any problems. It's all high quality forage down to the last blade of grass. Because of the spreading angle adjustment system, you can always adapt your machine according to the harvesting situation. In the working position, the transport chassis is folded up in front of the rotors, which ensures an optimum centre of gravity.

As a result, the chassis does not stand in the ejection path of the forage and the loading created by the centre rotors is reduced to a minimum – perfect pre-requisites for producing your high quality forage.



Tines with equal sides



Specifications

Three-point linkage

Model	MF TD 454 DN	MF TD 524 DN	MF TD 676 DN	MF TD 776 DN	MF TD 868 DN
Mounting category	Cat I and II	Cat I and II	Cat I and II	Cat I and II	Cat I and II
Working width approx. m	4.50	5.20	6.60	7.70	8.60
Transport width approx. m	2.65	3.00	2.90	3.00	2.90
Parking height approx. m	2.40	2.60	3.30	3.65	3.30
Rotors	4	4	6	6	8
Tine arms per rotor	6	6	6	6	6
Anti-tine loss protection	●	●	●	●	●
Tyres	16 / 6.50 - 8	16 / 6.50 - 8	16 / 6.50 - 8	6 x 16 / 6.50 - 8	6 x 16 / 6.50 - 8 2 x 18.5 / 8.50 - 8
Power demand approx. kW/hp	22/30	22/30	30/41	60/82	70/95
Hydraulic outlets	1 x SAV	1 x SAV	1 x SAV	1 x SAV	1 x SAV, 1 x DAV*
PTO rpm	540	540	540	540	540
PTO shaft	Overload (radial pin clutch)	Overload (radial pin clutch)	Overload (radial pin clutch)	Overload safety clutch (radial pin clutch)	Overload safety clutch (radial pin clutch)
Warning panels	●	●	●	●	●
Electrical lighting	○	○	○	○	○
Weight approx. kgs	574	606	822	946	1,172

Trailed

Model	MF TD 1008 TR HYDRO	MF TD 1310 TR HYDRO
Mounting category	Drawbar	Drawbar
Working width approx. m	10.20	12.70
Transport width approx. m	2.78	2.78
Transport length approx. m	6.83	8.07
Rotors	8	10
Tine arms per rotor	6	6
Anti-tine loss protection	●	●
Rotor tyres	16/6.50-8	16/6.50-8
Power demand approx. kW/hp	35/48	45/61
Hydraulic outlets	1 x SAV	1 x SAV
PTO rpm	540	540
PTO shaft	Overload (radial pin clutch)	Overload (radial pin clutch)
Warning panels	○	○
Electrical lighting	○	○
Weight approx. kgs	1090	1305

Transport Chassis

Model	MF TD 776 TRC	MF TD 868 TRC	MF TD 1008 TRC	MF TD 1310 TRC
Mounting category	Drawbar	**	**	**
Working width approx. m	7.7	8.6	10.2	12.7
Transport width approx. m	3.0	3.0	2.94	2.94
Transport length approx. m	4.48	4.4	5.7	5.7
Rotors	6	8	8	10
Tine arms per rotor	6	6	6	6
Anti-tine loss protection	●	●	●	●
Rotor tyres	4 x 16 / 6.50 - 8	6 x 16 / 6.50 - 8	6 x 16 / 6.50 - 8	8 x 16 / 6.50 - 8
	2 x 18.5 / 8.50 - 8	2 x 18.5 / 8.50 - 8	2 x 18.5 / 8.50 - 8	2 x 18.5 / 8.50 - 8
Chassis Tyres	215/65-16	10.0 / 80-12	10.0 / 75-15.3	10.0 / 75-15.3
Power demand approx. kW/hp	30/41	40/54	40/54	66/90
Hydraulic outlets	1 x SAV	1 x DAV*	1 x SAV, 1 x DAV*	1 x SAV, 1 x DAV*
PTO rpm	540	540	540	540
PTO shaft	Overload safety clutch (radial pin clutch)	Overload safety clutch (radial pin clutch)	Overload safety clutch (radial pin clutch)	Overload safety clutch (radial pin clutch)
Warning panels	●	●	●	●
Electrical lighting	●	●	●	●
Weight approx. kgs	1237	1,660	1,860	2,160

* DAV with float position

** Delivery of the machine ex works without towing drawbar. Please always observe the rules and regulations for connection equipment between tractor and machine which are applicable in your respective country or region.

- Not available/not applicable ● Standard specification ○ Optional

Illustrations show some of the special equipment. Some machines available in selected countries only.
The images provided do not necessarily correspond to the most recent version of standard equipment.



MASSEY FERGUSON

A world of experience. Working with you.



Web: www.MasseyFerguson.com

Facebook: www.Facebook.com/MasseyFergusonGlobal

Twitter: [Twitter.com/MF_EAME](https://twitter.com/MF_EAME)

Instagram: [Instagram.com/MasseyFergusonGlobal](https://www.instagram.com/MasseyFergusonGlobal)

YouTube: www.YouTube.com/MasseyFergusonGlobal

Blog: Blog.MasseyFerguson.com



MASSEY FERGUSON® is a worldwide brand of AGCO.
© AGCO Limited. 2017 | A-A-16595/1117 | English/1117



Responsible forest management

